

## Silicon NPN Phototransistor, RoHS Compliant

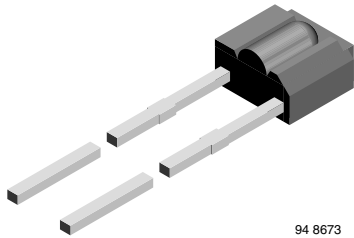

94 8673

### DESCRIPTION

TEST2600 is a silicon NPN phototransistor with high radiant sensitivity in black, miniature, side view plastic package with daylight blocking filter. Filter bandwidth is matched with 900 nm to 950 nm IR emitters.

### FEATURES

- Package type: leaded
- Package form: side view
- Dimensions (L x W x H in mm): 3.6 x 2.2 x 3.4
- High radiant sensitivity
- Daylight blocking filter matches with 940 nm emitters
- Fast response times
- Angle of half sensitivity:  $\varphi_1 = \pm 30^\circ$ , horizontal
- Package matches with IR emitter series TSSS2600
- Lead (Pb)-free component in accordance with RoHS 2002/95/EC and WEEE 2002/96/EC

**RoHS**  
COMPLIANT

### APPLICATIONS

- Optical switches
- Counters and sorters
- Interrupters
- Tape and card readers
- Encoders
- Position sensors

### PRODUCT SUMMARY

COMPONENT	$I_{ca}$ (mA)	$\varphi$ (deg)	$\lambda_{0.5}$ (nm)
TEST2600	2.5	$\pm 30$	850 to 980

#### Note

Test condition see table "Basic Characteristics"

### ORDERING INFORMATION

ORDERING CODE	PACKAGING	REMARKS	PACKAGE FORM
TEST2600	Bulk	MOQ: 5000 pcs, 5000 pcs/bulk	Side view

#### Note

MOQ: minimum order quantity

### ABSOLUTE MAXIMUM RATINGS

PARAMETER	TEST CONDITION	SYMBOL	VALUE	UNIT
Collector emitter voltage		$V_{CEO}$	70	V
Emitter collector voltage		$V_{ECO}$	5	V
Collector current		$I_C$	50	mA
Collector peak current	$t_p/T = 0.5, t_p \leq 10$ ms	$I_{CM}$	100	mA
Total power dissipation	$T_{amb} \leq 55^\circ\text{C}$	$P_V$	100	mW
Junction temperature		$T_j$	100	$^\circ\text{C}$
Operating temperature range		$T_{amb}$	- 40 to + 85	$^\circ\text{C}$
Storage temperature range		$T_{stg}$	- 40 to + 100	$^\circ\text{C}$
Soldering temperature	$t \leq 3$ s, 2 mm frpm case	$T_{sd}$	260	$^\circ\text{C}$
Thermal resistance junction/ambient	Connected with Cu wire, 0.14 mm <sup>2</sup>	$R_{thJA}$	450	K/W

#### Note

$T_{amb} = 25^\circ\text{C}$ , unless otherwise specified

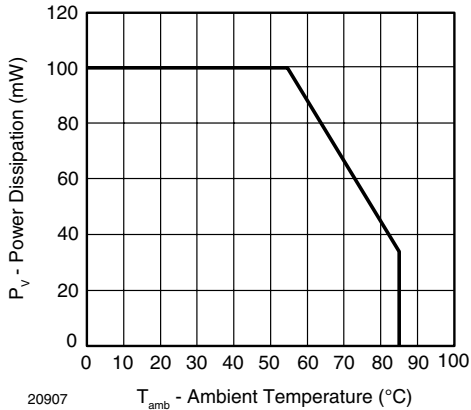

Fig. 1 - Power Dissipation Limit vs. Ambient Temperature

BASIC CHARACTERISTICS						
PARAMETER	TEST CONDITION	SYMBOL	MIN.	TYP.	MAX.	UNIT
Collector emitter breakdown voltage	$I_C = 1 \text{ mA}$	$V_{(BR)CEO}$	70			V
Collector emitter dark current	$V_{CE} = 20 \text{ V}, E = 0$	$I_{CEO}$		1	100	nA
Collector emitter capacitance	$V_{CE} = 5 \text{ V}, f = 1 \text{ MHz}, E = 0$	$C_{CEO}$		6		pF
Collector light current	$E_e = 1 \text{ mW/cm}^2, \lambda = 950 \text{ nm}, V_{CE} = 5 \text{ V}$	$I_{ca}$	1	2.5		mA
Angle of half sensitivity	horizontal	$\varphi_1$		$\pm 30$		deg
	vertical	$\varphi_2$		$\pm 60$		deg
Wavelength of peak sensitivity		$\lambda_p$		920		nm
Range of spectral bandwidth		$\lambda_{0.5}$		850 to 980		nm
Collector emitter saturation voltage	$E_e = 1 \text{ mW/cm}^2, \lambda = 950 \text{ nm}, I_C = 0.1 \text{ mA}$	$V_{CEsat}$			0.3	V
Turn-on time	$V_S = 5 \text{ V}, I_C = 5 \text{ mA}, R_L = 100 \Omega$	$t_{on}$		6		$\mu\text{s}$
Turn-off time	$V_S = 5 \text{ V}, I_C = 5 \text{ mA}, R_L = 100 \Omega$	$t_{off}$		5		$\mu\text{s}$
Cut-off frequency	$V_S = 5 \text{ V}, I_C = 5 \text{ mA}, R_L = 100 \Omega$	$f_c$		110		kHz

**Note**

$T_{amb} = 25 \text{ }^\circ\text{C}$ , unless otherwise specified

**BASIC CHARACTERISTICS**

$T_{amb} = 25 \text{ }^\circ\text{C}$ , unless otherwise specified

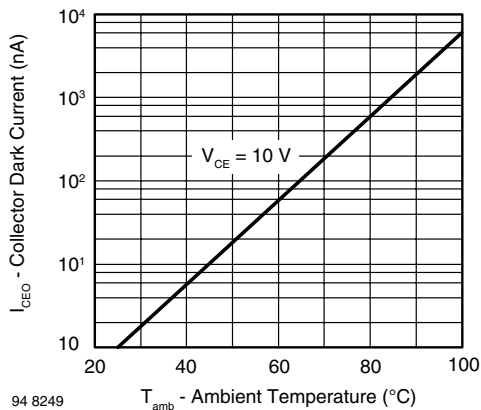

Fig. 2 - Collector Dark Current vs. Ambient Temperature

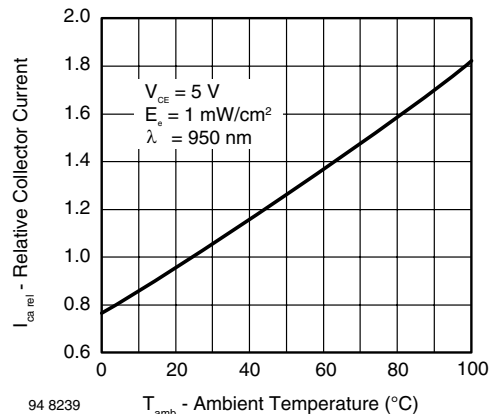

Fig. 3 - Relative Collector Current vs. Ambient Temperature

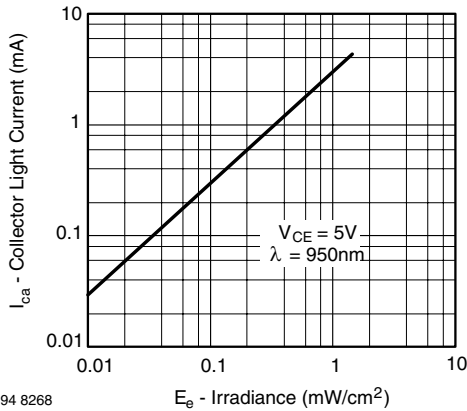

Fig. 4 - Collector Light Current vs. Irradiance

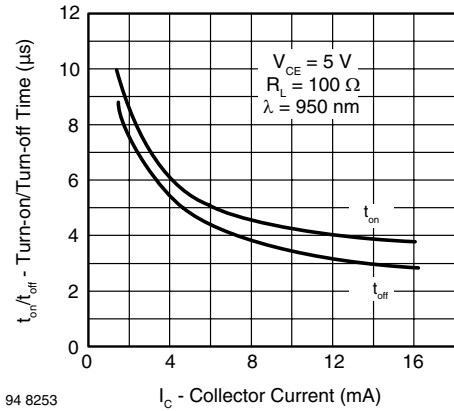

Fig. 7 - Turn-on/Turn-off Time vs. Collector Current

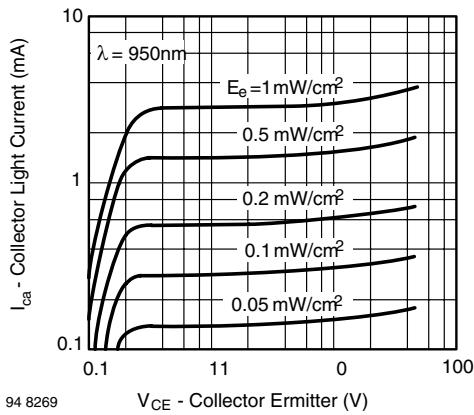

Fig. 5 - Collector Light Current vs. Collector Emitter Voltage

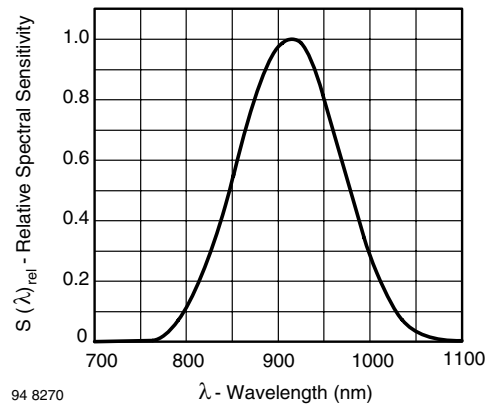

Fig. 8 - Relative Spectral Sensitivity vs. Wavelength

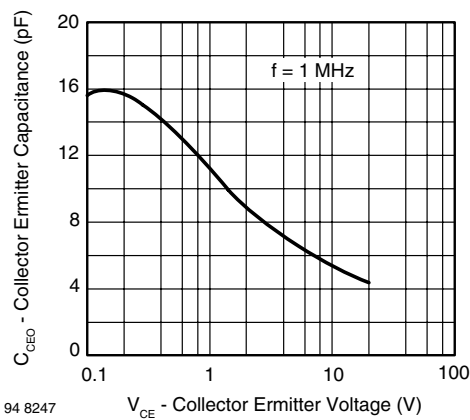

Fig. 6 - Collector Emitter Capacitance vs. Collector Emitter Voltage

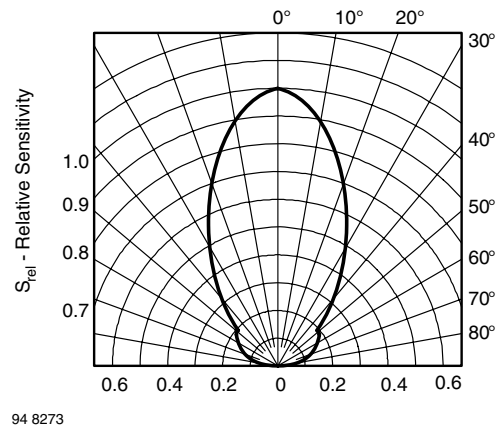
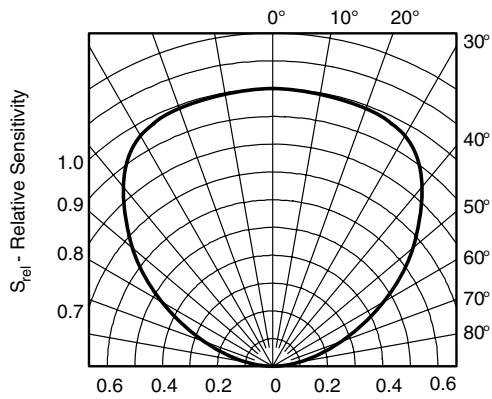

Fig. 9 - Relative Radiant Sensitivity vs. Angular Displacement



94 8274

Fig. 10 - Relative Radiant Sensitivity vs. Angular Displacement

**PACKAGE DIMENSIONS** in millimeters

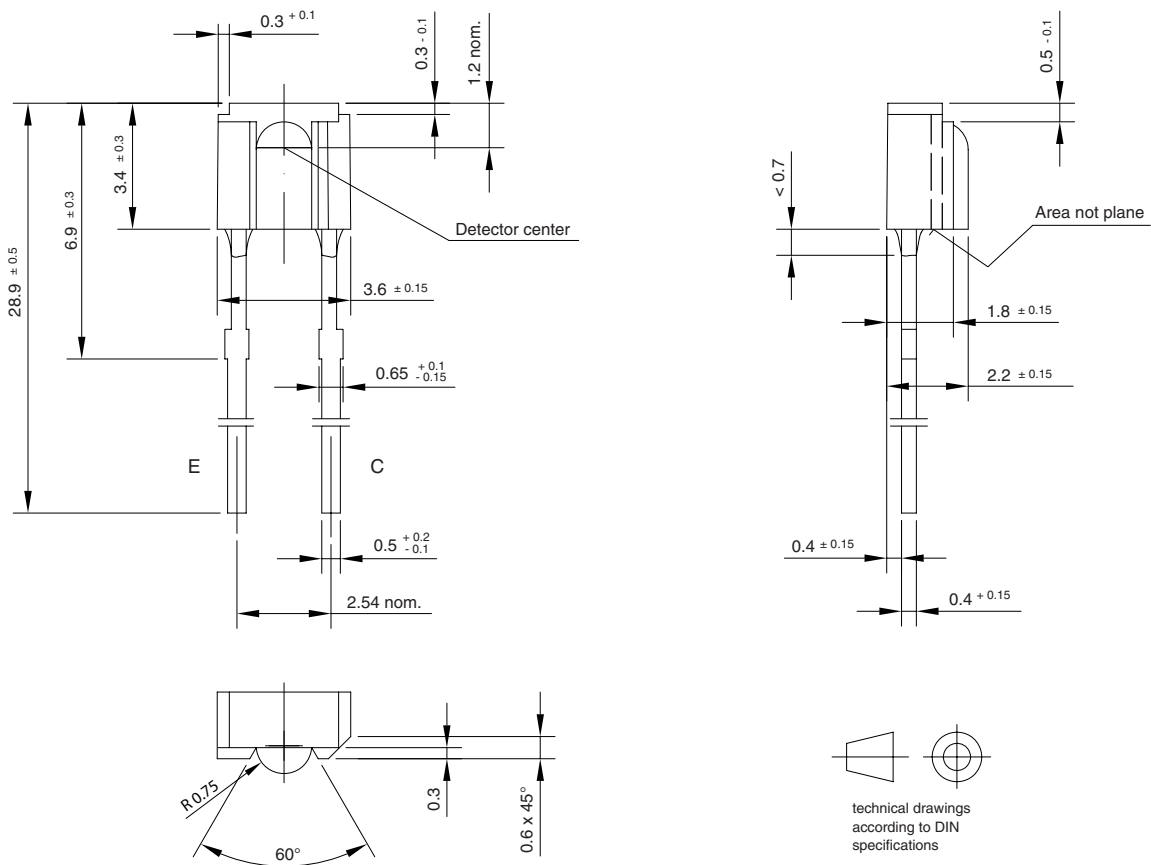

Drawing-No.: 6.544-5242.01-4

Issue: 3; 18.04.96

95 11487



## Disclaimer

All product specifications and data are subject to change without notice.

Vishay Intertechnology, Inc., its affiliates, agents, and employees, and all persons acting on its or their behalf (collectively, "Vishay"), disclaim any and all liability for any errors, inaccuracies or incompleteness contained herein or in any other disclosure relating to any product.

Vishay disclaims any and all liability arising out of the use or application of any product described herein or of any information provided herein to the maximum extent permitted by law. The product specifications do not expand or otherwise modify Vishay's terms and conditions of purchase, including but not limited to the warranty expressed therein, which apply to these products.

No license, express or implied, by estoppel or otherwise, to any intellectual property rights is granted by this document or by any conduct of Vishay.

The products shown herein are not designed for use in medical, life-saving, or life-sustaining applications unless otherwise expressly indicated. Customers using or selling Vishay products not expressly indicated for use in such applications do so entirely at their own risk and agree to fully indemnify Vishay for any damages arising or resulting from such use or sale. Please contact authorized Vishay personnel to obtain written terms and conditions regarding products designed for such applications.

Product names and markings noted herein may be trademarks of their respective owners.